MetOcean Drymate Connector Range

The **MetOcean** metal shell connector series has a long established pedigree in deep ocean and harsh environment applications.

The design utilises industry standard MIL spec. inserts incorporated into rugged metal shells to withstand the extreme conditions during handling, deployment and service.

The modular design offers great versatility with multiple options for electrical performance, size, pin configuration and material specification.

Rated to 7,100m, these connectors can be supplied Oil filled, moulded in Polyurethane or Polyethylene or unterminated for field installation.



Key Features and Benefits

- 9 shell sizes, 2 to 61 contacts, 8 to 20AWG
- Additional pinout variants, including hybrid Electrical/Coax available – contact Sales for details
- MIL-DTL-26482 Specification inserts, up to 5 keyway variants
- Available in 316 Stainless Steel as standard, titanium, aluminium, naval brass, non-metallic or other options available on request
- Voltage rated from 700Vdc to 1500Vdc, current from 7.5A to 45A (single pin)
- Standard and reverse gender configurations for connectors or bulkheads
- COTS inserts and in-house manufactured housings for cost effective, short lead time supply
- Proven sealing design accommodates non-standard inserts – Fibre Optic, RF/Coax, hybrid etc.
- Options include electrical screening, strain member termination, fully waterblocked or oil filled
- Bulkhead mounting variants and conductor tails to suit individual requirements
- Right angled and multiway breakout moulding options

Standard Specifications :-

Temperature :	-20 °C to 100°C	Body :	Stainless 316L
Contact IR :	>999MΩ @ 1,000Vdc	Insert :	Polychloroprene / Plated Aluminium
Mated Depth :	7,100m	Contacts :	Copper Alloy / Gold over Nickel Plate
Locking Nut :	Acetal or Brass	O Rings :	Nitrile N170

Moulded MetOcean Connector Plug Dimensions

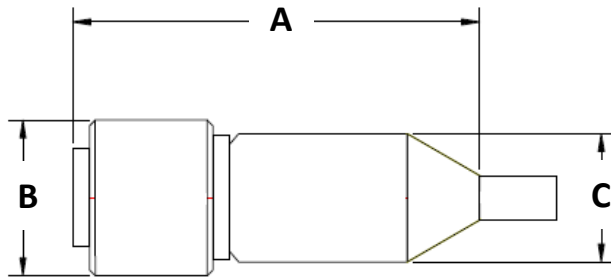

SIZE	'A'	'B'	'C'
8	91	33	31
10	91	35	29
12	91	38	37
14	91	42	42
16	91	48	47
18	110	50	49
20	120	53	52
22	135	56	55
24	145	60	59





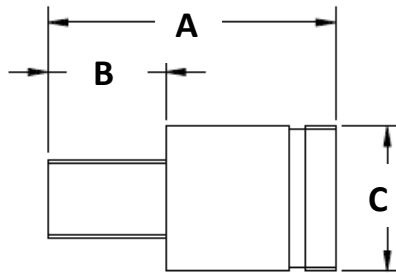







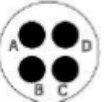

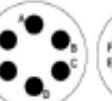







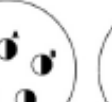



All dimensions in mm (Approx)

Standard MetOcean Bulkhead Receptacle Dimensions



SIZE	'A'	'B' THREAD	'B'	'C'
8	60	½" -20 UNF	24	27
10	60	5/8" -18 UNF	24	30
12	60	¾" -18 UNF	24	33
14	60	7/8" -14 UNF	24	37
16	60	1" -12 UNF	24	43
18	60	1 1/8" -12 UNF	24	46
20	62	1 1/4" -12 UNF	24	50
22	64	1 3/8" -12 UNF	24	53
24	63	1.5" -12 UNF	24	55

All dimensions in mm (except where stated)

SIZE	METOCEAN CONNECTOR CONTACT ARRANGEMENT (FACE VIEW)
8	    08-02 08-03a 08-03b 08-04
10	   10-02 10-06 10-07
12	    12-03 12-08 12-10 12-14
14	       14-02 14-04 14-05 14-12 14-15 14-19 14-4/1
16	   16-04 16-08 16-26
18	   18-02 18-11 18-32
20 22 24	     20-16 20-41 22-04 22-55 24-61

● = size 20 contacts (voltage rating at sea level = 700V) ● = size 16 contacts (voltage rating at sea level = 1200V)
 ● = size 12 contacts (voltage rating at sea level = 1500V) ● = size 8 contacts (voltage rating at sea level = 1500V)

MetOcean Part Numbering

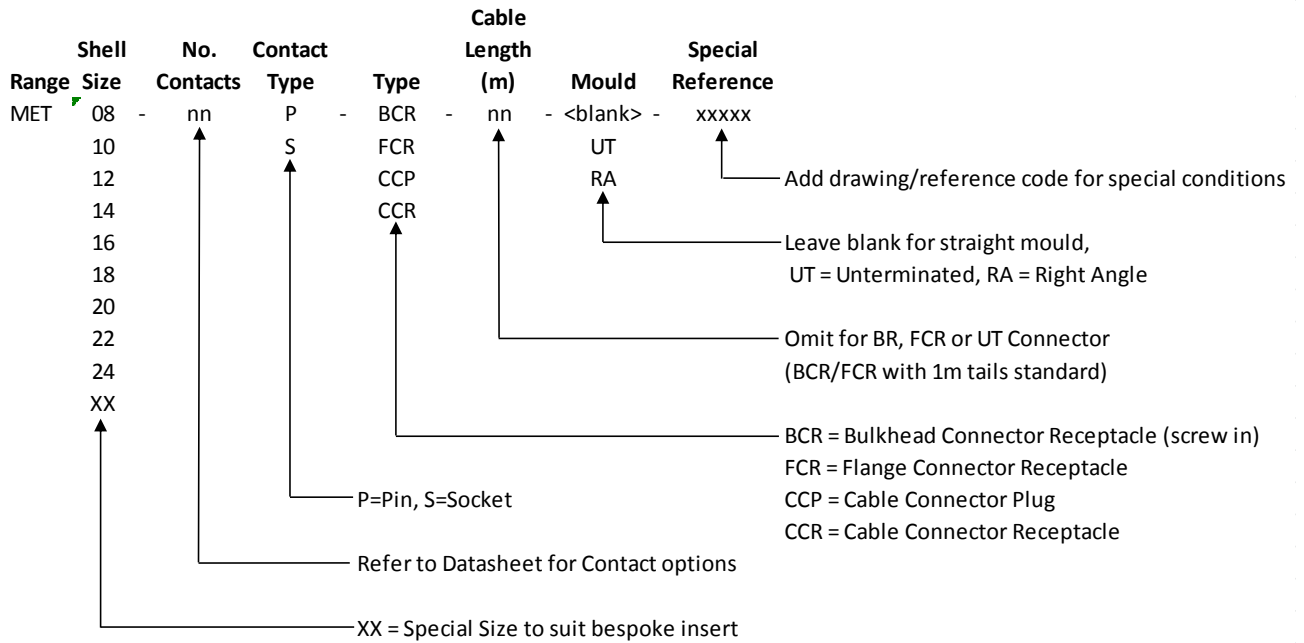

Examples: - **MET14-04P-CCP-3M-RA**
 Size 14, 4-pin Connector, right angled moulding to 3m cable

MET14-04S-BCR
 Size 14, 4-socket Bulkhead (mates with item above)

MET22-55P-FCR-03985
 Size 22, 55-pin Flanged Bulkhead, with a bespoke/special requirement

